

VMPC BUSINESS JSC.

SGMPC PTE. LIMITED

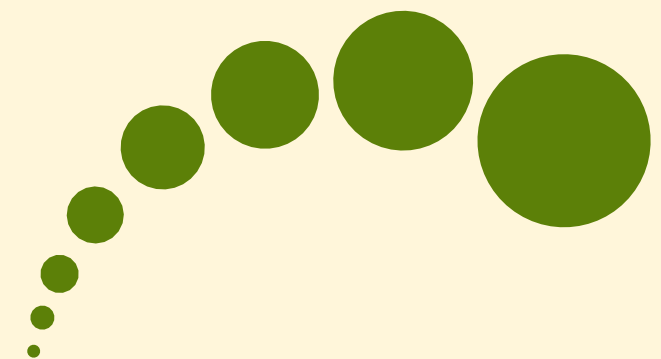
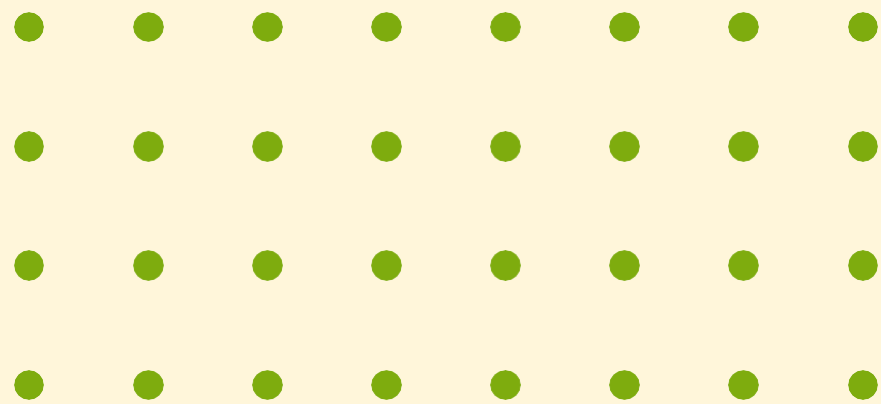



TABLE OF CONTENT

OPEN LETTER

ABOUT COMPANY

VISION, MISSION, VALUE

WHAT WE DO

OUR PRODUCT

THE FACTORY

OUR CUSTOMER

MEET OUR TEAM

CONTACT

THANK YOU!



OPEN LETTER



MRS. JENNY
DIRECTOR

“ VMPC'S GOAL IS TO BEST mEET CUSTOMERS' NEEDS BY PROVIDING mATERIALS AND CONSULTING & TECHNOLOGY SOLUTIONS TO HELP CUSTOMERS ACHIEVE PRODUCTS WITH HIGH QUALITY AT OPTImAL PRODUCTION COSTS. VMPC'S TECHNICAL EXPERTS ARE READY TO SHARE EXPERIENCES & PROVIDE AFTER-SALES SERVICES FOR YOU ACCORDING TO YOUR NEEDS.

WITH OUR EFFORTS, OPEN-mINDEDNESS, CREATIVITY AND ComMITmENT, VMPC EXPECTS AND BELIEVES TO BE A REPUTABLE BRAND & BECOMES YOUR TRUSTED PARTNER.

”



GROUP COMPANY: VMPC AND NGUYEN VINH

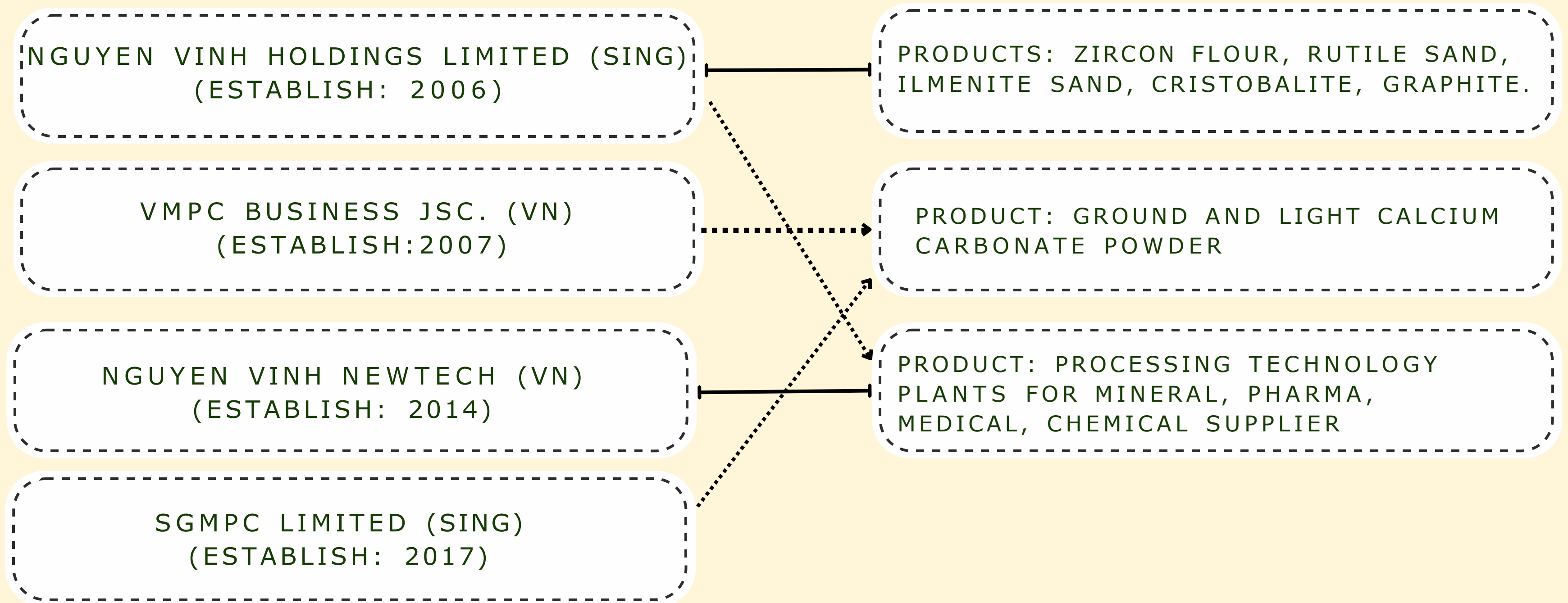

ABOUT COMPANY

VMPC JSC. (VMPC BUSINESS JOINT STOCK COMPANY) IS AN ENTERPRISE SPECIALIZING IN INDUSTRIAL MINERAL MATERIALS. WITH OVER 15 YEARS OF EXISTENCE & DEVELOPMENT, VMPC IS A LEADING SUPPLIER OF CALCIUM CARBONATE POWDER IN VIETNAM. VMPC'S PRODUCTS ARE PROCESSED FROM GERMANY'S MOST ADVANCED TECHNOLOGICAL LINES.

VMPC'S HIGHLY QUALIFIED PERSONNEL, WITH INTERNATIONAL BUSINESS CAPABILITIES & EXPERIENCE HAVE HELPED VMPC REACH OUT TO HIGH-QUALITY GLOBAL MARKETS, ESPECIALLY SOUTH EAST ASIA, CENTRAL EAST MARKETS & APEC COUNTRIES.

ADDRESSES:

1. HEADQUARTERS (VMPC): LK02-19, NO. 117, 3-5 GAMUDA GARDENS STREET, C2 URBAN AREA - GAMUDA GARDENS, TRAN PHU WARD, HOANG MAI DISTRICT, HANOI, VIETNAM.
2. SINGAPORE OFFICE (SMGPC): 10 ANSON ROAD, #31-10 INTERNATIONAL PLAZA, SINGAPORE 079903.

VMPC WISHES TO ESTABLISH LONG-TERM DEVELOPMENT RELATIONSHIPS WITH CUSTOMERS ON THE BASIS OF WILLINGNESS TO SHARE OPPORTUNITIES, COMPETITIVE CHALLENGES, SUCCESSES AND FUTURE BENEFITS THROUGH:

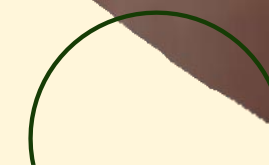
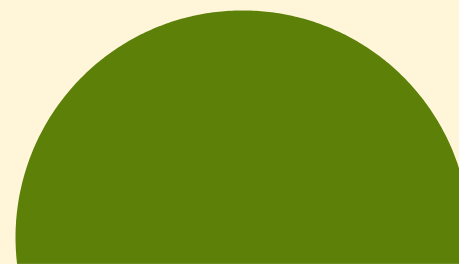
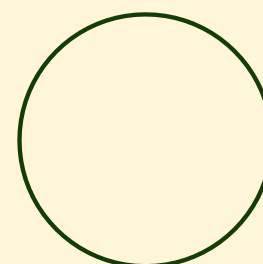

MISSION, VALUE, VISION



- **MISSION:** SYMBIOSIS AND ACCOMPANYING CUSTOMERS.
- **VALUE:** QUALITY- SUSTAINABLE EFFICIENCY, WIN-WIN COOPERATION.
- **VISION:** BECOME A STRONG, PRESTIGE AND BENEFIT BRAND FOR EMPLOYEES, CUSTOMERS & COMMUNITY.





WHAT WE DO

- BUSINESS CONNECTION ●
- SUPPLY RAW MATERIALS ●
- DOMESTIC AND INTERNATIONAL SALES ●
- PRODUCT LIFE CIRCLE ●





OUR PRODUCT

WE POSSESS THE PUREST AND BRIGHTEST SOURCE OF CALCIUM CARBONATE IN VIET NAM AND EXPLOIT WITH HIGH STANDARD OF SUSTAINABILITY. IT IS THE "MOTHER" NATURE WHO GIVE US ONE OF THE BEST SOURCE OF CALCIUM CARBONATE IN THE WORLD. AS OUR CUSTOMERS OFTEN SAY: "YOUR CALCIUM CARBONATE IS WHITER THAN WHITE" AND MOSTLY USED IN VARIOUS APPLICATIONS IN PAINT, PLASTIC, PAPER, RUBER ETC.

OUR MOST MODERN EUROPEAN ADVANCE TECHNOLOGY FROM GERMAN HOSOKAWA ALPINE WHICH IS THE MOST FAMOUS BRAND IN THIS FIELD HELP US PROVIDE: HIGH G CONSTANT PRODUCT QUALITY, CUSTOMIZED PRODUCT AND DIFFERENT PARTICLE SIZE DOWN TO TOP CUT OF 4 MICRON.





OUR PRODUCT



Calcium carbonate powder (coated)

Application:

- Plastic industry
- Paint industry
- Paper industry
- Ceramic industry
- Foundry industry



Calcium carbonate powder (uncoated)

Application:

- Plastic industry
- Paint industry
- Paper industry
- Ceramic industry
- Foundry industry
- Environment Treatment



Light/ Precipitated Calcium Carbonate powder

Application:

- Plastic industry
- Paint industry
- Paper industry
- Rubber industry
- Ceramic industry
- Foundry industry



OUR PRODUCT

TDS EXAMPLE:

PRODUCT DATA SHEET

PRODUCT GRADE: VM1

DESCRIPTIONS:

Natural, Super fine, White Uncoated Calcium Carbonate Powder

RAW MATERIAL:

CHEMICAL ANALYSIS:

CaCO₃ content:	98 % min
Iron Oxide- Fe ₂ O ₃ content:	0.02% max
Magnesium- MgO content:	0.30% max
Aluminium Oxide – Al ₂ O ₃ content:	0.20% max
Silica- SiO ₂ content:	0.20% max

PHYSICAL PROPERTIES:

Specific Gravity:	2.70 g/cm ³
Hardness	3 Moh

PRODUCED MATERIAL:

TECHNICAL DATA:

Moisture	0.20% max
DOP oil Absorption	23g/100g CaCO ₃
PH Value	8-9%
Whiteness	≥ 98%
Brightness	≥ 96%

FOR TDS,

WE WILL ALWAYS SEND TDS OF PRODUCT TO OUR CUSTOMERS.

THE RATIO OF CaCO₃, WHITENESS, BRIGHTNESS AND PARTICLE SIZE OF PRODUCT COULD CHANGES ON CUSTOMER REQUIREMENTS.



THE FACTORY

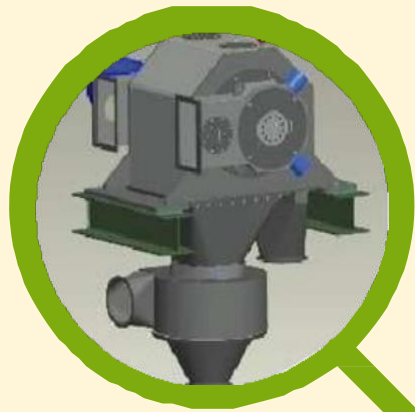

Location: Yen Bai and Nghe An, Vietnam

Production line: Hosokawa Alpine most modern line.

Capacity: ~5000MT/month (10 mic Uncoated)



OUR MAIN CUSTOMER



**JOTUN MEIA FZ-LLC
(BANGLADESH)**



**BRB CABLE INDUSTRIES
LIMITED (BANGLADESH)**



**WALTON HI-TECH INDUSTRIES
LTD (BANGLADESH)**



**MATADOR PLASTIC AND
RUBBER INDUSTRIES LTD.
(BANGLADESH)**



**ASIAN PAINTS
BANGLADESH LTD.**



**SURFA COATS PVT LTD
(INDIA)**



MEET OUR TEAM



JENNY (DIRECTOR)



EMMA (SALES MANAGER)



ROSA (SALES EXECUTIVE)



FRANK (SALES EXECUTIVE)



MEET OUR TEAM



LILY (SALES EXECUTIVE)



LAN (DOCUMENT STAFF)



HIEU (DOCUMENT STAFF)

@reallygreatsite

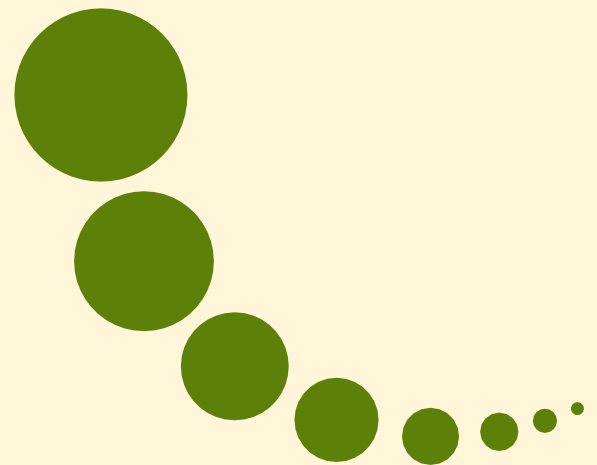



CONTACT

PHONE

(+84)-4-35134082/3

ADDRESS

**Tran Phu ward, Hoang Mai dist.,
Hanoi, Vietnam**

EMAIL

frank@vmpc.com.vn

WEBSITE

<https://vmpc.com.vn/>



THANK YOU